

Vertical Steplift PV-30





Our vertical steplift is perfect for private or public building entrances, specifically when some steps are an architectural barrier for people with impaired mobility or for wheelchair users.

Our elevator versatility allows installation at any indoor or outdoor shaft or space, facilitating the access up to 3 metres in height.

With a simple operation frame, it includes a security system that ensures the correct transport of people with reduced mobility and wheelchair users.

Vertical platforms PV-30 are an inexpensive and efficient alternative to lifts when the travel is not too high.



PV WITH SUPPLEMENTARY WIDE GUIDES INCLUDING BUILT IN POWER UNIT

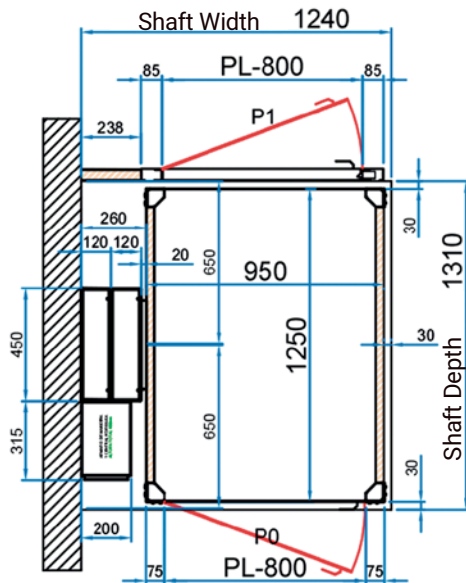

PV WITHOUT SUPPLEMENTARY GUIDES FOR POWER UNIT

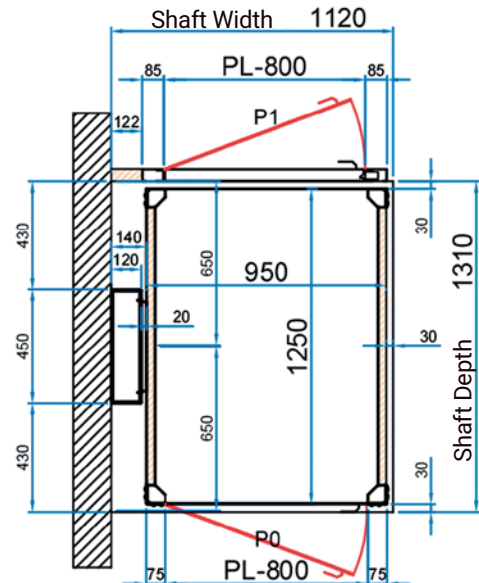

PIT (150mm) + TRAVEL	TOTAL COLUMN HEIGHT
0-500	2620
501-1000	2620
1001-1500	3120
1501-2000	3620
2001-2500	4120
2501-3000	5230

STANDARD MODEL FEATURES

Pit	150 mm
Exterior Cabin Measures	950 x 1250 mm
Shaft Measures (cabinet option 5m)	1120 x 1310 mm
Shaft measures with wide guides including cabinet	1240 x 1310 mm
Load capacity	300 kg
Speed	0.15 m/s
Electric power	230 V a.c.
Maximum travel	3000 mm
Finishing	RAL 7012, front and control panel RAL 9006, rubber flooring and side glass walls.

All our products are manufactured according to Directive 2006/42/CE / EN81-41



+34 936 249 930
info@onlevel.es
www.onlevelquality.com

DISTRIBUTED BY: